

2008

Energy conservation in traditional buildings



ENGLISH HERITAGE

The information in this publication is based on current knowledge. Whilst every effort has been made to ensure the accuracy of the advice given, English Heritage does not accept liability for loss or damage arising from the use of this information. This publication is intended only as a guide. It has no statutory authority, and should not be used as a substitute for professional advice. The guidance provided here deals only with the practical aspects of installing the equipment. The acceptability of the installation will depend on the historic significance of the building or site being adapted. You are strongly advised to discuss the proposals informally with historic environment staff from your local council.

The inclusion in this publication of any company, group or individual, or any product or service, should not be regarded as either a recommendation or an endorsement by English Heritage or its agents.

PLANNING AND HISTORIC BUILDING LEGISLATION

ENGLISH HERITAGE SEEKS TO ENSURE THAT ANY WORKS TO A HISTORIC BUILDING DO NOT UNNECESSARILY DISTURB OR DESTROY HISTORIC FABRIC.

In decisions on how best to incorporate a renewable technology, the principles of minimum intervention and reversibility should be adopted whenever and wherever possible.

Installing external applications or double glazing will probably need planning permission. The local planning authority can grant permission under the Town and Country Planning Act 1990, and they will be looking for any issues concerning visual impact.

Installing external applications or double glazing on a listed building or a building in a conservation area will also need permission from the local planning authority under the Planning (Listed Buildings and Conservation Areas) Act 1990. Planning Policy Guidance (PPG) 15, Planning and the Historic Environment, can help you with this; see www.planningportal.gov.uk. Work of any kind to a Scheduled Monument requires consent from English Heritage under the Ancient Monuments and Archaeological Areas Act 1979.

CONTENTS

INTRODUCTION	1
Are you sitting comfortably?	2
Older homes are different	2
INSULATION	4
Insulating walls	4
Insulating below pitched roofs	4
Amounts of insulation	4
Plan the installation carefully	5
Removing existing insulation	5
Ground-floor insulation	5
DRAUGHT-PROOFING	6
WINDOWS	9
Double glazing	9
Secondary glazing	9
OTHER WAYS TO REDUCE ENERGY USE	10
GRANTS	10
USEFUL CONTACTS	11
Energy saving and climate change	11
Planning guidance	11
Insulation and draught-proofing	11
ACKNOWLEDGEMENTS	11

Front cover image showing buildings in Liskeard, Cornwall courtesy of Andrew More.

INTRODUCTION

English Heritage is the UK government's adviser on the historic environment. Central to our role is the advice we give to local planning authorities and government departments on development proposals affecting listed and traditional buildings, conservation sites and areas, terrestrial and underwater archaeological sites, designed landscapes and historical aspects of the landscape as a whole.

The UK government consider climate change is probably the greatest long-term challenge facing the human race and have made it a priority for the UK to cut our carbon dioxide concentrations, which are believed to contribute to climate change.

The UK government, wishing to reduce the country's dependence on fossil-fuel stores and to cut carbon dioxide emissions, has made a national goal of reducing carbon dioxide by 20 per cent below 1990 levels by 2010 and, in the long-term, reduce emissions by 60 per cent by 2050. They see this being achieved by every household and business taking measures to reduce their energy used.

For more information on the UK government's position on climate change, contact the UK Climate Impacts Programme (see Useful contacts).

This guide looks at a range of improvements that can be made to reduce the heat lost through a building's walls, windows, floor and roof. Most of these improvements are within the capabilities of a competent DIY enthusiast, but if you are not confident that you have the necessary skills, seek expert advice and help.

This guide is one of a series of guides looking at reducing energy consumption in traditionally constructed homes. While this guide considers improvements to a building's performance through insulation and energy efficiency measures, other guides will focus on the application of small-scale renewable energy technologies, explaining how each system works and what you need to consider if you wish to install it in or on a historic building. All the guides look at small-scale or 'Microgeneration' as it is known. Microgeneration is defined by Government as, "The production of heat and/or electricity on a small-scale from a low carbon source".

Before looking into alternative means of generating energy, it is important to investigate all available measures for conserving it. These include low-energy light bulbs, heating controls and, as set out in this guide, building insulation.

Other guides in the series will cover solar energy, heat pumps and combined heat and power, explaining how each system works and what you need to think about if you wish to install it in a traditional building.

ARE YOU SITTING COMFORTABLY?

Before considering how to reduce heat loss from your home, consider the factors that influence your feelings of comfort. For most of us these are temperature, relative humidity and air movement. Other factors are your age, the amount and type of clothing you're wearing and your level of activity.

We are all familiar with the effects of temperature and humidity, especially during warm, 'muggy' summers. Humidity that is too low can also be a problem, making the air feel too dry; many of us have also experienced the shock of static electricity, which is more likely to occur when humidity is low. Air movement also has a big influence on comfort: air blowing across your face may feel like a cooling breeze in summer, but in winter the same air speed and temperature will feel like a cold draught.

It is also important to remember that we now dress differently to our ancestors. Heating in homes, cars, workplaces and shops leads many of us to dress in a very similar way all year round, lightweight clothing being the norm in many homes and offices even in the middle of winter:



WHAT DO WE MEAN BY A TRADITIONAL BUILDING?

- Solid-wall construction
- Bay or sash window, single glazed
- No damp-proof course
- Likely to have been built before 1919

OLDER HOMES ARE DIFFERENT

In considering improvements for energy conservation it is important to remember that many traditional (historic) buildings perform very differently from modern buildings. Thought must be given to:

- Your home's construction, to avoid causing damage
- The importance of moisture movement in historic buildings
- Minimising disturbance to the existing fabric
- Reversing any changes without causing further damage
- Whether your home is of such quality that it should not be altered

The fabric of a traditional building usually needs to 'breathe': to release and absorb moisture, for example from rising damp, driving rain, defects and condensation. Moisture can move through traditional permeable building materials until it evaporates, internally and externally. Modern impermeable building products obstruct this process: instead of keeping moisture out, they can often trap it inside, accelerating decay processes.

The main risks to traditional (historic) buildings are:

- Moisture trapped within the building materials.
- Condensation within unheated areas of the building.
- Condensation at thermal bridges (see the box below), especially corners
- Ventilation and heating which are insufficient for removing moisture

In a permeable building, it is important not to reduce ventilation rates too much, as this could trap moisture within the building.

Successful control of moisture levels in a traditional (historic) building may depend on:

- Adequate ventilation
- Use of building materials that are 'hygroscopic' which allows moisture movement into and out of the building materials.
- Minimising barriers to moisture flow

- 2 As a rule of thumb, a traditional building needs to be ventilated at a rate of 0.8 to 1.0 air changes per hour – twice that for a modern building. Since infiltration rates in many traditional buildings exceed this value, draught-proofing is normally beneficial

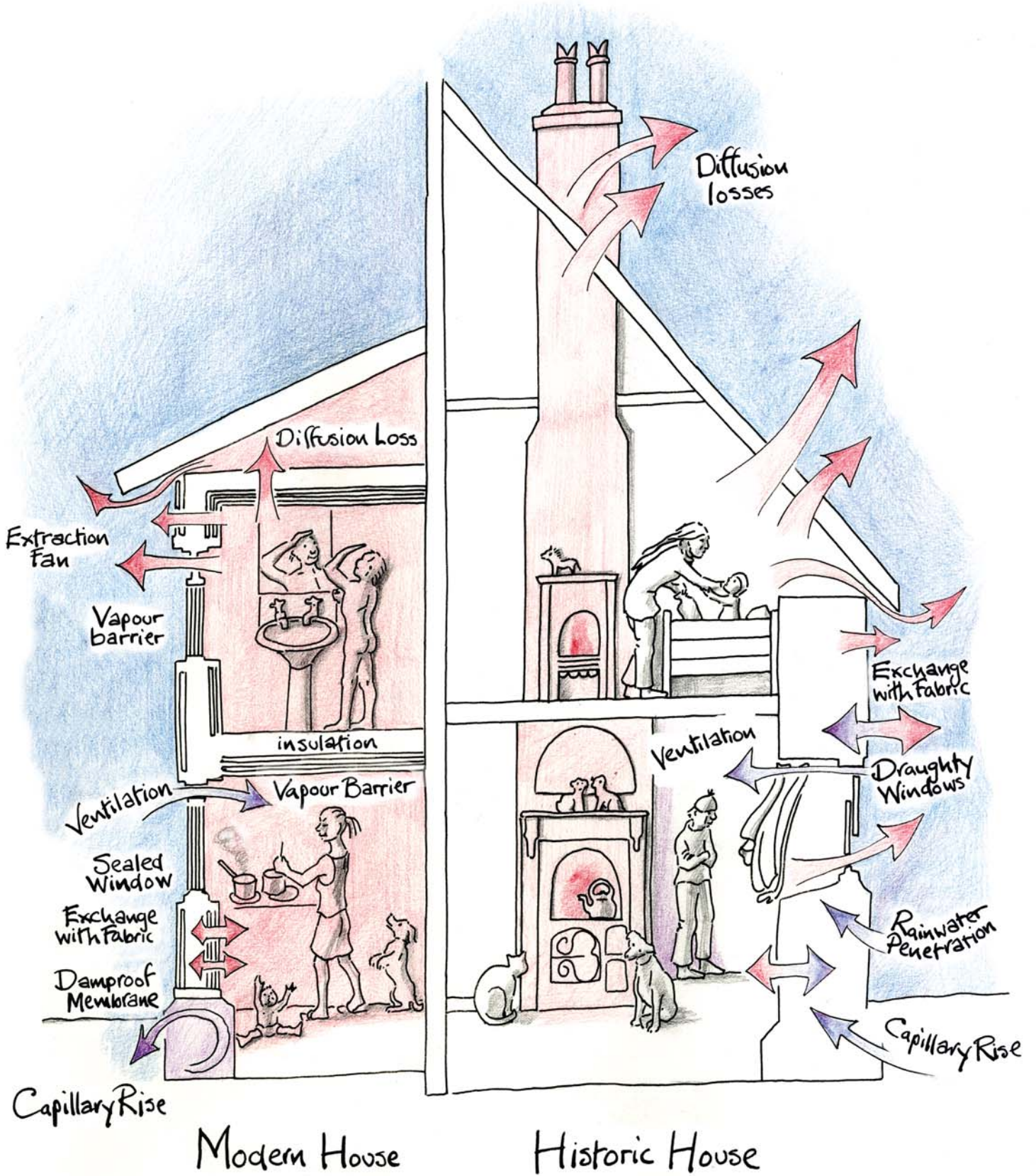

INSULATION

INSULATION MATERIALS FOR TRADITIONAL BUILDINGS

Natural fibre-based materials such as sheep's wool and hemp fibre are suitable for use as insulation in traditional buildings. These have good thermal insulation properties and do not hinder the movement of moisture.

Materials such as fibreglass and mineral wool have a tendency to hold moisture. In older buildings this can increase the risk of damp, timber decay and mould growth.

In selecting the most appropriate insulation material it is important to ensure that it will continue to perform for many years to come. If the material is likely to settle then allowance should be made for this, including means to prevent it from flowing out through the eaves or being blown about in the loft space if there is strong air movement.

INSULATING WALLS

With their solid walls, traditional buildings can potentially be insulated either internally or externally. Internal lining of rooms is possible within the competence of DIY, but external application is best left to competent builders. In either case you should seek expert advice before proceeding, as the works are likely to require building control and, if your building is protected (listed or in a conservation area), planning consent.

3 Where has all the heat gone? Reducing heat loss and draughts keeps the heat where you need it – inside your home



Before Insulation

After Insulation

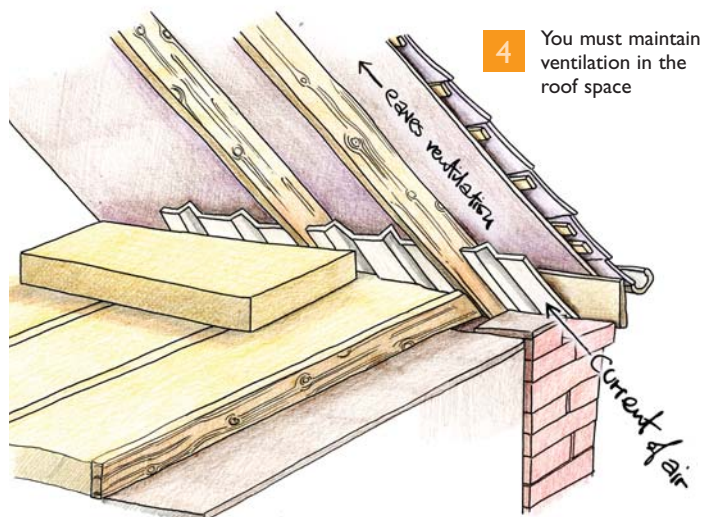

4 You must maintain ventilation in the roof space

INSULATING BELOW PITCHED ROOFS

Insulation above the top floor ceiling is one of the easiest and cheapest means of improving a building's energy efficiency. It can be carried out successfully in traditional and historic buildings if it is approached with care and consideration for their special circumstances, particularly the risk of condensation. Relatively thick layers of insulation will not cause problems if they are installed carefully and if the materials are compatible with the performance of older buildings. Loose-fill cellulose insulation can be installed between ceiling joists as a DIY improvement.

If you already have some insulation you could simply add to what is already there. When laying additional insulation make sure you maintain the air flow through the loft space.

If you wish to lay loft boards or flooring in order to use your loft space for storage, you may need to first add additional timber joists on top off at right angles to the existing floor joists to provide enough depth for the insulation.

By reducing heat flow from below, improving insulation in this way will reduce the temperature in the loft space. If you have water tanks and pipes in the loft space, make sure that these too are adequately insulated, to stop them freezing. Check also that no electric cables or lights are covered with insulation as this could cause them to overheat.

AMOUNTS OF INSULATION

To meet current good practice you will need about a 250mm thickness of sheep's wool, 250mm of hemp or 225mm settled thickness of cellulose fibre insulation.

Make sure that the existing ceiling can take the extra weight of additional joists and insulation.

PLAN THE INSTALLATION CAREFULLY

Thermal bridge: If thermal performance is improved in one area with the addition of insulation, while an adjacent area is not insulated, a local cold spot – known as a thermal bridge or cold bridge – is created.

Most traditional buildings were not designed with insulation in mind. Before starting, plan how you will do it. Draw a sketch of the floor of the loft, and consider the following questions:

- How will each corner and awkward area be insulated?
- Will building paper be needed to separate insulation from damp walls?
- Will eaves ventilators be required to prevent insulation from blocking ventilation?
- Are there areas of sloping ceilings? These will need special attention, for example access may be difficult.
- How will you move around the loft space when the insulation is in place?
- What areas need access, and where will items be stored? What about access for maintenance, including to small or awkward spaces?
- Are services in the loft space out of use or likely to need repairs or upgrading in the near future? Is this a good opportunity to remove redundant pipe and cable runs, aerials etc, or to renew that old cold-water tank?
- How will plumbing in the loft space be insulated?
- Will wiring in the loft space need renewal in the next few years? Will it be accessible once the space is insulated?

Where blown or vertical insulation is required this must be carried out by an approved specialist contractor such as a member of the National Association of Loft Insulation Contractors.

REMOVING EXISTING INSULATION

Existing loft insulation is likely to be of fibreglass or mineral wool, not really suitable for older buildings. If the insulation is old, in poor condition or poorly installed you should replace it. If there are any signs of dampness in the roof timbers, such as staining or fungal growth, near the insulation, this is also a sign that the insulation should be replaced.

- 5** Place no insulation directly below the cold-water tank: heat from the room below helps prevent the tank from freezing

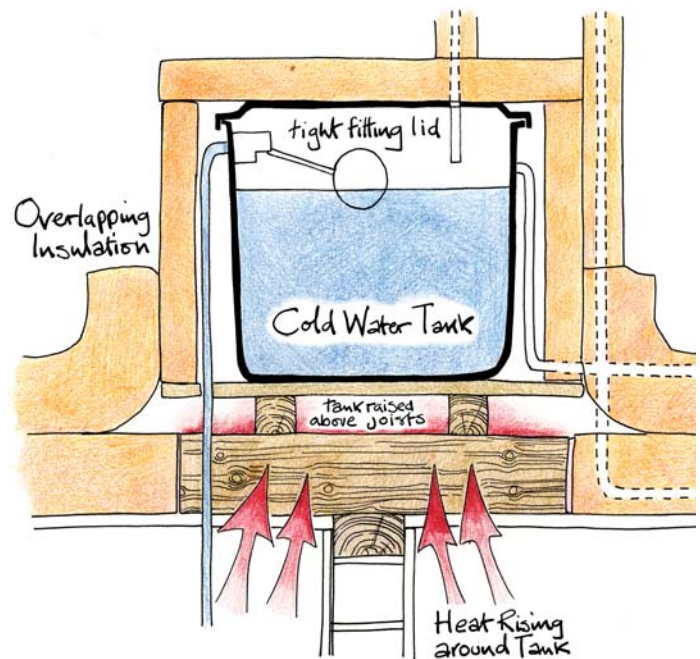

When handling mineral wool or fibreglass insulation you should wear protective clothing, including a dust mask, at all times.

GROUND-FLOOR INSULATION

Undertaking floor insulation is likely to be beyond the competence of all but the most experienced. It should only be considered if other major refurbishment works are planned to the ground floor.

These works will require major disruption in the lifting of existing floor finishes, and possible ground excavations in the case of solid floors, so it is best to leave them to experienced building contractors.



6 Missing insulation: make sure your insulation is complete. (Photograph courtesy of English Heritage)

DRAUGHT-PROOFING

TRADITIONAL BUILDINGS ARE OFTEN OVER-VENTILATED, SO DRAUGHT-PROOFING IS ONE OF THE BEST AND LEAST INTRUSIVE WAYS OF IMPROVING COMFORT AND REDUCING HEAT LOSS, WITH LITTLE OR NO CHANGE TO A BUILDING'S APPEARANCE.

It can also help to reduce noise and dust ingress. Windows and doors are often a major source of air infiltration, and draught-proofing can improve the situation - provided sufficient ventilation remains for the health of the building and its occupants and the proper functioning of appliances such as heaters, boilers and cookers. Don't forget that letter boxes, loft hatches and even

Draughts can make people feel cold, which may lead them to turn up the heating and run it for longer.

the cat flap can let in cold air, so make sure that these too are draught-proofed.

There are no specific standards for draught-proofing existing buildings, but building regulations may apply if doors or windows are beyond repair and must be replaced, or if the building is undergoing a change of

Warning: windows or doors that are firmly stuck in place may have taken on a structural role, taking some of the weight of the wall above. Don't force them open: they might break, and it has not been unknown for parts of the wall to collapse. First assess the structural situation, and seek advice from a competent structural engineer.

use. If either of these is the case, talk to your local building control team and building conservation officer before proceeding.

If carried out carefully, many draught-proofing measures are compatible with the principles of building conservation. Measures are typically reversible, with few lasting consequences and no loss of historic fabric.

If a building has been effectively (but not excessively) draught-proofed, you may need to consider the removal of water vapour produced at source – particularly from kitchens, bathrooms and laundries – so as not to let it spread about the building unnecessarily. Local air extraction (natural or mechanical) may be required in these areas. Unheated spaces such as roof and floor voids are often designed to be cross-ventilated by outside air, and should not be draught-proofed.

Special care should be taken in rooms with open fires or other combustion appliances, to avoid depriving them of sufficient air. Specialist advice should be sought before sealing any rooms containing gas- or oil-burning appliances.

Special care should be taken with any damp building: only after faults have been repaired and the building dried out with the assistance of good ventilation should draught-proofing be considered. Damp cellars may not benefit at all from draught-proofing.



7 Using existing shutters can help cut down heat loss through windows



- 1 Plastic or sprung V- or Z-strip
- 2 Glued or pinned silicone rubber tubing
- 3 Parting bead (Ventrolla)
- 4 Meeting rail brush (Ventrolla)
- 5 Bottom sash or sill brush (Ventrolla)
- 6 Parting bead weatherstrip (Mighton)
- 7 Brush for meeting rails (Draughtseal)
- 8 Standard weatherseal (Mighton)
- 9 Staff bead or button rod (Ventrolla)
- 10 Silicone seal (Draughtseal)

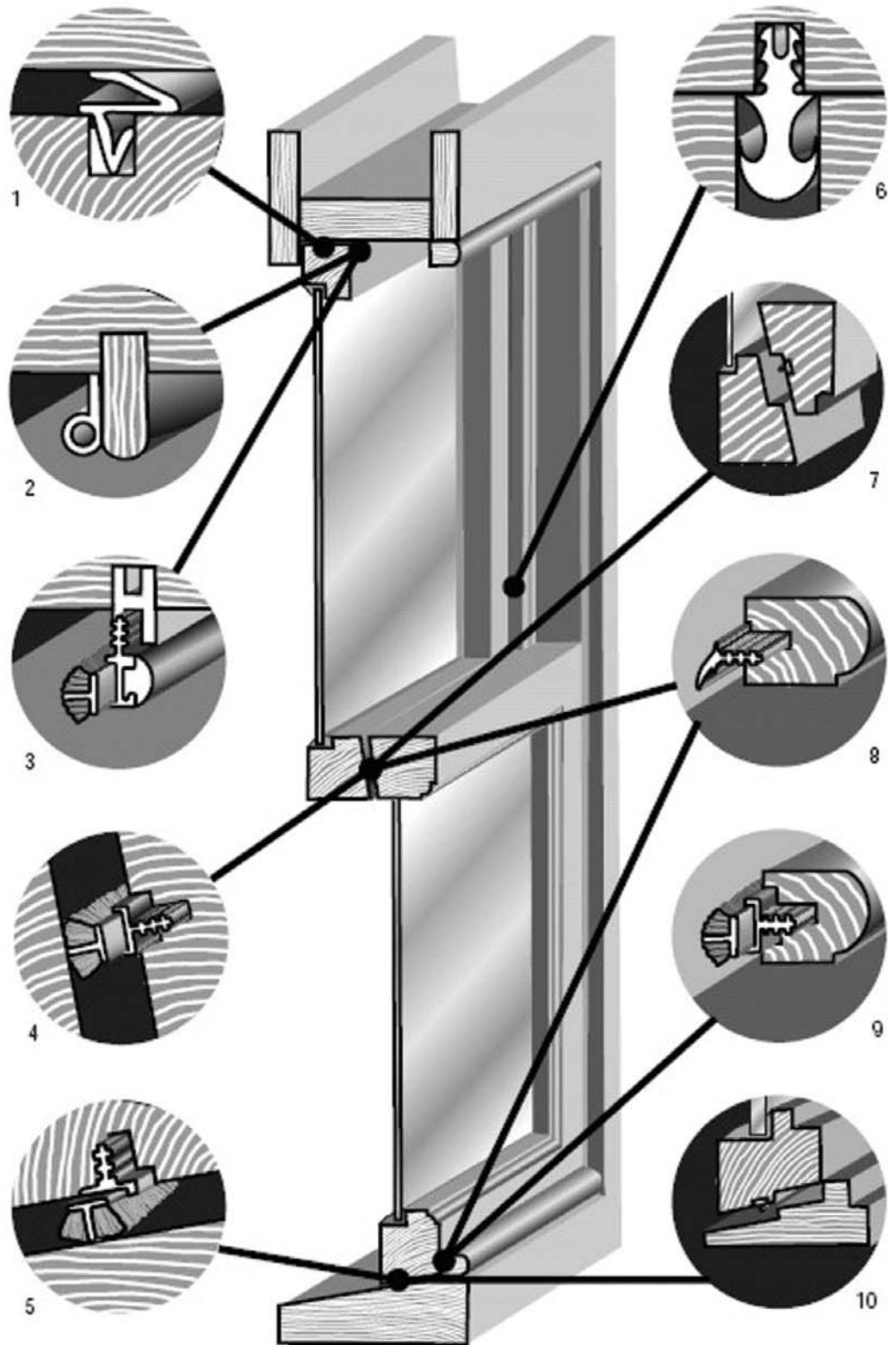

8 Draught-stripping on windows.
(Courtesy of English Heritage)

Single Glazed

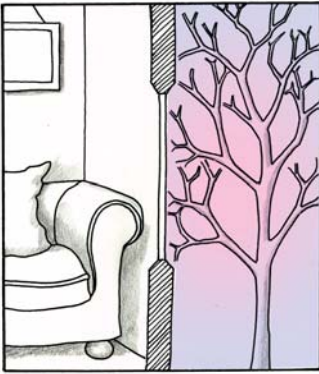

U value 4.8

Single Glazed with Curtains

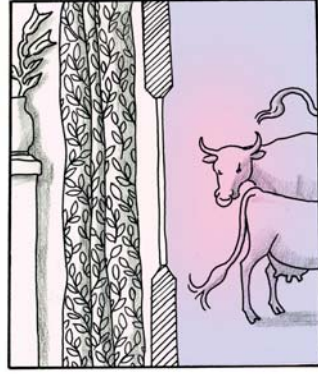

U value 3.6

Single Glazed with Shutters



U value 3

Secondary Glazing



U value 2.9-3.4

Double Glazed with 12mm Gap

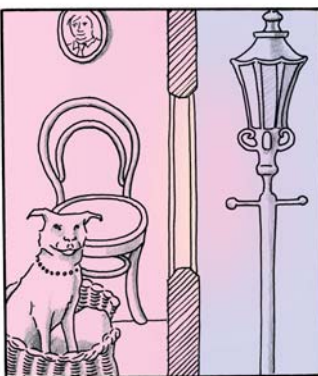

U value 2.8



U value 2

WINDOWS

DOUBLE GLAZING

Double glazing is now fitted as standard in all new homes and whenever replacement of a complete window is required. While it would take many years to get a return on the cost of new windows simply from the savings in energy costs, they can improve a home's overall internal comfort level by reducing cold draughts.

SECONDARY GLAZING

An alternative to the installation of new double glazing is secondary glazing, which retains the existing window and therefore preserves the property's external appearance. While secondary glazing cannot achieve the same level of performance as a new double-glazed window unit (see Fig 10), it offers considerable improvement in heat retention over single glazing.

Secondary glazing ranges from simple, one-season plastic film methods undertaken by householders to permanent, purpose-built systems. Permanent secondary glazing, featuring hinged, lift-out or sliding panes, can be fitted by a competent DIY homeowner or by a professional builder or installer.



10

Secondary glazing reduces heat loss while retaining the existing window and its external appearance. (Photograph courtesy of English Heritage)

9 Indicative U values (W/m² deg C) for vertical glazing, with wooden or PVCu frames

OTHER WAYS TO REDUCE ENERGY USE

IN ADDITION TO MINIMISING HEAT LOSS THERE ARE MANY OTHER WAYS TO REDUCE ENERGY CONSUMPTION IN YOUR HOME:

- Install a more fuel-efficient boiler
- Have heating appliances serviced annually by a licensed technician (CORGI-registered in the case of gas appliances)
- Install heating controls, including thermostatic radiator valves and a boiler timer
- Avoid over-heating, and use thermostats to control room temperature rather than opening windows to let heat out
- Insulate pipework and hot-water cylinders
- Fit photocells or timers to external lights
- Change incandescent lamps to energy-efficient versions

In addition to your local council's website, a good source of advice on energy conservation is the non-profit Energy Saving Trust (see Useful contacts), funded by government and the private sector.

GRANTS

YOUR LOCAL COUNCIL AND THE ENERGY SAVING TRUST ARE ALSO GOOD SOURCES OF INFORMATION ON GRANTS AND RELATED SCHEMES TO HELP COVER THE COSTS OF ENERGY EFFICIENCY MEASURES.

Many energy suppliers also offer financial help with such improvements. Grants for the installation of renewable energy systems are often available only to those who have already undertaken some or all of the energy conservation measures discussed in this guide.

USEFUL CONTACTS

ENERGY SAVING AND CLIMATE CHANGE

UK Climate Impacts Programme (UKCIP)
Oxford University Centre for the Environment
 Dyson Perrins Building
 South Parks Road
 Oxford OX1 3QY
 Tel: 01865 285717
www.ukcip.org.uk

Energy Saving Trust
 21 Dartmouth Street
 London SW1H 9BP
 Tel: 020 7222 0101
www.energysavingtrust.org.uk

Historic Environment, Local Management (HELM)
 English Heritage
 1 Waterhouse Square
 138-142 Holborn
 London EC1N 2ST
 Tel: 020 7973 3000
www.helm.org.uk

PLANNING GUIDANCE

Department for Communities and Local Government
 Eland House
 Bressenden Place
 London SW1E 5DU
 Tel: 020 7944 4400
www.communities.gov.uk

English Heritage
 1 Waterhouse Square
 138-142 Holborn
 London EC1N 2ST
 Tel: 020 7973 3000
www.english-heritage.org.uk

INSULATION AND DRAUGHT-PROOFING

National Insulation Association
 2 Vimy Court
 Vimy Road
 Leighton Buzzard
 Bedfordshire LU7 1FG
 Tel: 01525 383313
www.nationalinsulationassociation.org.uk

ACKNOWLEDGEMENTS

English Heritage would like to acknowledge the help of the following people in the production of this guide:

Text by David Drewe,
 English Heritage Building services
 Engineering and Safety Team (BsEST)

All Illustrations by Judith Dobie,
 Centre for Archaeology,
 English Heritage

Edited by John King

Produced by Creative Services,
 English Heritage

March 2008

Product Code: 51367

Building services
Engineering and Safety Team
English Heritage
1 Waterhouse Square
138-142 Holborn
London EC1N 2ST



ENGLISH HERITAGE

